

DATE	PROJECT	LOCATION	TYPE
------	---------	----------	------



PRODUCT FEATURES

- Micro light source for Millwork, Showcase, Museum & Furniture
- Adjustable pole length, Rotatable head
- Constant voltage DC 24V driver
- Available in black, gold (Special order option: silver)
- Beam options (18°, 32°, 46°)
- Control with 0-10V, DALI, DMX, Zigbee

PRODUCT SPECIFICATIONS

Power Input	24V DC Constant Voltage
Color Rendering Index	CRI >90
Available CCTs	2700K, 3000K, 3500K, 4000K
Energy efficiency	65lm/W
Operating Temperature Ranges	32-113°F (0-45°C)
Control	0-10V, DALI, DMX, Zigbee
Finish	Black, Gold (Special Order Option-Silver)
Beam Angle	18°, 32°, 46°
Lamp life	50,000hr / 70%
Warranty	5 year

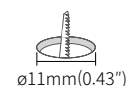

SPECIFICATION

Performance data shown below for 3000K CCT. Refer to individual luminaire IES files for other CCT options.

Model Name	Power Input	Lamp Power	Luminous Flux	Luminous Flux	Color Rendering Index	Color Temperature	Beam Angle	Operating Temperature
MCR-PL1 (color)K-24V-46	DC 24V	1.2W	79 lm	65 lm/W	CRI > 90	2700K / 3000K / 3500K / 4000K	18°, 32°, 46°	0-45°C (32-113°F)

SPECIFICATION GUIDE

NOT TO BE USED FOR ORDERING. The Specification Guide is intended solely to ensure that all options are considered.

MODEL	COLOR	BEAM ANGLE	FINISH	MOUNTING	DRIVER	CONTROLS	VOLTAGE
MCR-PL1		C90					
MICRO POLE	27K -2700K 30K -3000K 35K -3500K 40K -4000K	18° 32° 46°	BK - Black GD - Gold SV - Silver (Special Order Option)	RM - Recessed Mount	CP - Cable/Plug HW - Hard Wire TD - 3rd Party Drivers Consult Factory	NDM - Non-Dim 0-10V - DALI - DALI Interface DMX - DMX Interface	120V 230V 277V

DIMENSIONS

Micro Pole

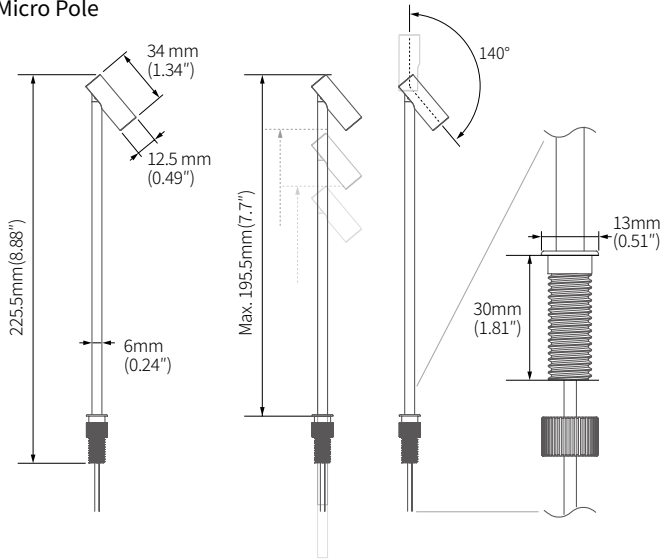

INSTALLATION

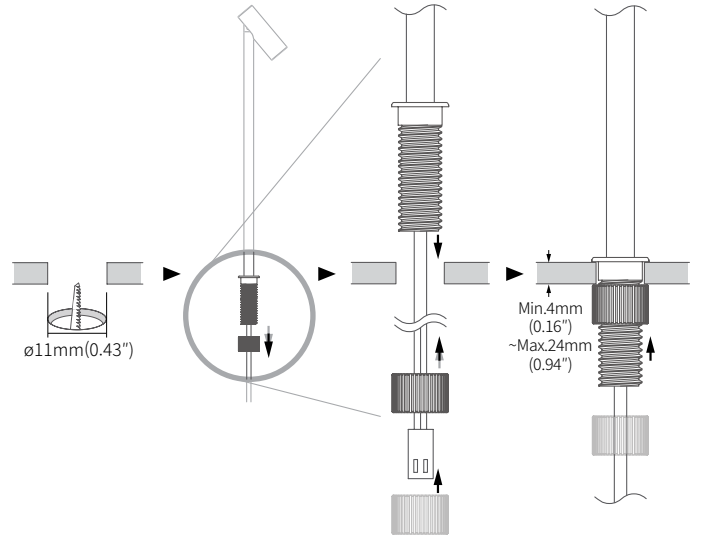

⚠ don't cut Cable in front of Circuit

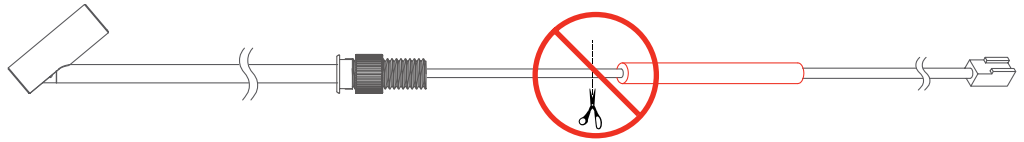

BEAM SPREADS

MCR-PL1 30K-24V-18-BK

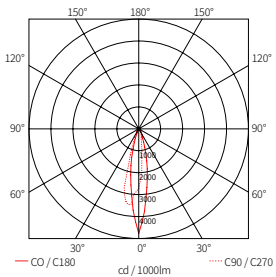

MCR-PL1 30K-24V-32-BK

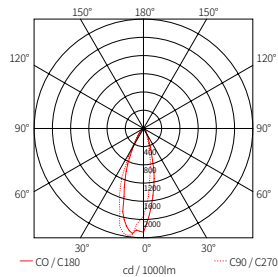

MCR-PL1 30K-24V-46-BK

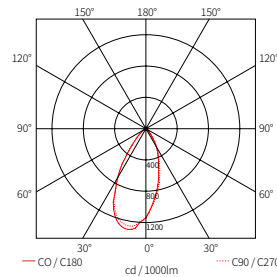

COMPONENTS



FLX Micro POLE
 __MCR-PL1-(color)K-24V-18-BK
 __MCR-PL1-(color)K-24V-18-GD
 • 18°, 32°, 46° angles aer available
 • Other finishes available as special order



Control Interface (Zigbee)
 __FDD-L2Z



12 Port Hub
 __D12P-HUB
 Included with Cord and Plug drivers. Order separately for Hard Wire or 3rd Party Drivers



Wireless Control (Zigbee Switch)
 __FSM-Z1



LED Drivers
 __FLC30-24V/XL (30W) *
 __FLC75-24V/XL (75W) *
 With distributor and power cord 1800mm (6')



Dimming Interface (0-10V)
 __FDC-L10 *
 Max. 100W (100W/CH, 1CH)



Door and motion sensor
 __FLS-M24V

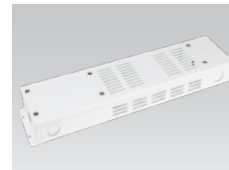

Driver Junction Box
 __MHWB-FLE



Control Interface (0-10V)
 __FDD-L20
 Max. 200W (100W/CH, 2CH)

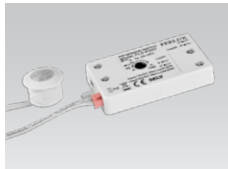

Occupancy sensor
 __FLS-P24V



Hard Wire Driver
 __XLD200-224V-FCL-DIM (0-10V)
 __XLD75-124V-FC * (90V to 300V)



Control Interface (DALI)
 __FDD-L1DA
 Max. 200W (100W/CH, 1CH)

A larger selection of drivers are available including remote and hard wire drivers. Please consult factory.



Hard Wire Driver
 __FLE60-24V-L10-DIM (Linear)
 __FLE90-24V-L10-DIM (Linear)



Control Interface (0-10V,DMX512)
 __FDA-L2MO
 Max. 200W (100W/CH, 2CH)
 __FDA-L5M
 Max. 200W (50W/CH, 5CH)

* FLC30, FLC75 and XLD75 require the FDC-L10 for 0-10V dimming