

DATE PROJECT LOCATION TYPE



PRODUCT FEATURES

- Seamless Spot Free Illumination
- UV-resistant Silicon material
- Close Pitch LEDs
- Top/Vertical Bend
- Control with FDD-L20, 0-10V
- Indoor and Outdoor Application
- Tunable color range 22K-40K

PRODUCT SPECIFICATIONS

Lamp Power	18.9 W/M (5.7 W/ft)
Power Input	24V DC Constant Voltage
Color Rendering Index	CRI >90
Available CCTs	SC(2200K-4000K)
Operating Temperature Ranges	-4°F to 122°F (-20°C to 50°C)
Control	FDD-L20, 0-10V
Material	Silicone
Beam Angle	130°
Maximum Length	5,000mm (16.4')
Minimum Length	50mm (1.97")
Bend Diameter	100mm (3.93")
Lamp life	50,000hr / 70%
Warranty	5 year Warranty
IP Rate	IP67 with Factory Termination
	IP65 with Field Termination

SPECIFICATIONS TABLE



Model Name	Color Temperature	Lamp Power	Luminous Flux	Lumen/W
FN2 SC-24V-C90	2200K-4000K	18.9 W/M (5.7 W/ft)	256 lm/ft	45 lm/W

PHYSICAL SPECIFICATIONS

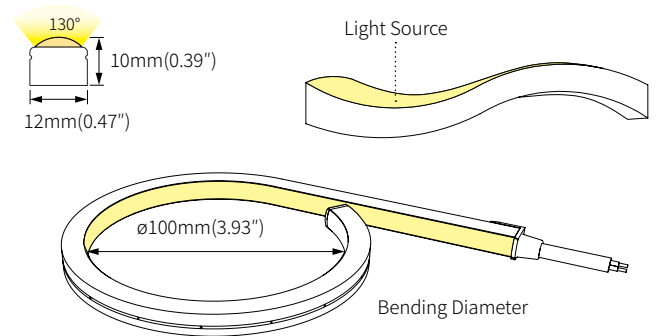

SPECIFICATION GUIDE

NOT TO BE USED FOR ORDERING. The Specification Guide is intended solely to ensure that all options are considered.

MODEL	COLOR	FEED TYPE	MOUNTING	EXTRUSION	DRIVER	CONTROLS	VOLTAGE
FN2	SC-22K-40K	C90	STD - Flat Brackets	EXL- 4' Extrusion EXL-FLEX - 3.3' Flexible Extrusion	CP - Cable/Plug HW - Hard Wire TD - 3rd Party Drivers Consult Factory	FDD-L20	120V 230V 277V
FN2	SC-22K-40K	STD - Straight Feed BS - Bottom Feed*	STD - Flat Brackets			0-10V	

* Available, As Special Order Consult Feelux Lighting

BEAM SPREADS

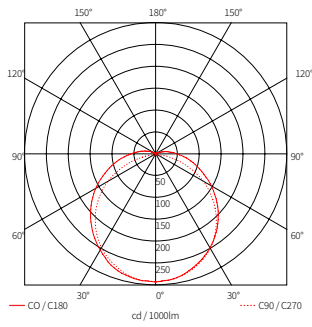

FN2 SC-24V-1M
45 lm/W
866 lm

INSTALLATION - Bracket

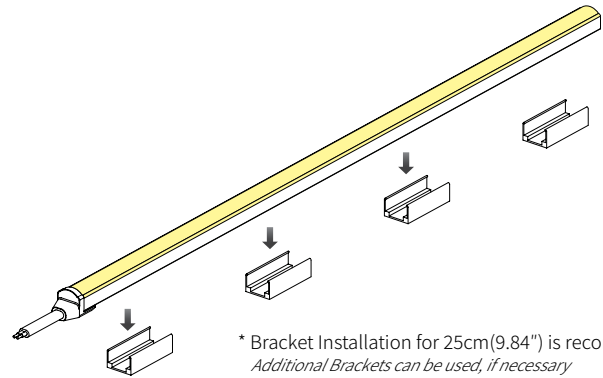

INSTALLATION - Field Termination (IP65)

* Components

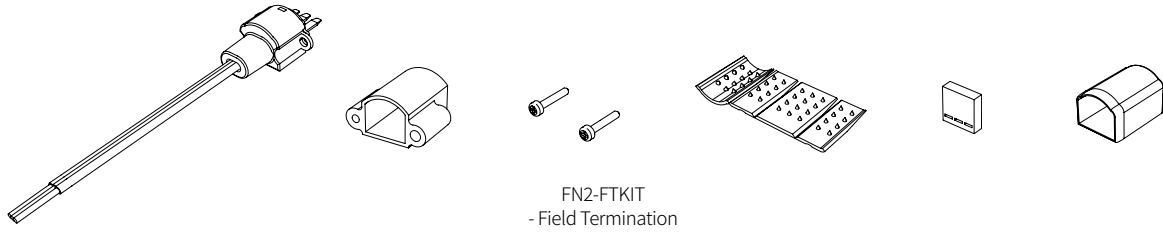

* Expanded View

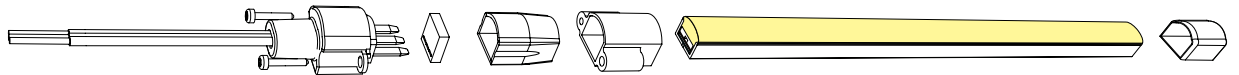

COMPONENTS

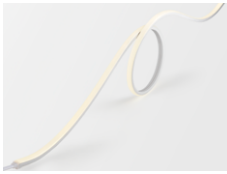

FLXible Neon 2-Straight Feed

- __FN2 SC-24V-C90-5M(16.4')
- __FN2 SC-24V-C90-4M(13.1')
- __FN2 SC-24V-C90-3M(9.8')
- __FN2 SC-24V-C90-2M(6.6')
- __FN2 SC-24V-C90-1M(3.3')



Control Interface required

- __FDD-L20
- Max. 200W (100W/CH, 2CH)



12 Port Hub

- __D12P-HUB
- Included with Cord and Plug drivers. Order separately for Hard Wire or 3rd Party Drivers



FLXible Neon 2-Bottom Feed

- __FN2 SC-24V-C90-BS-5M(16.4')
- __FN2 SC-24V-C90-BS-4M(13.1')
- __FN2 SC-24V-C90-BS-3M(9.8')
- __FN2 SC-24V-C90-BS-2M(6.6')
- __FN2 SC-24V-C90-BS-1M(3.3')



LED Drivers

- __FLC30-24V/XL (30W)
- __FLC75-24V/XL (75W)
- With distributor and power cord 1800mm (6')



Mounting Brackets

- __FN2-BRACKET1

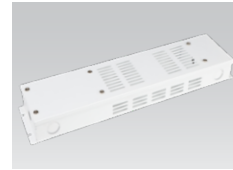

Driver Junction Box

- __MHWB-FLE

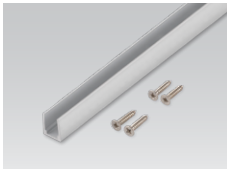

FN2 Extrusion Line

- __FN2-EXL (4')



Hard Wire Driver

- __XLD200-224V-FCL-DIM (0-10V)
- __XLD75-124V-FC (90V to 300V)

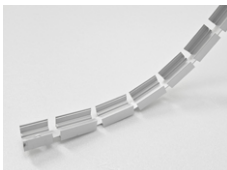

FN2 Flexible Extrusion Line

- __FN2-EXL-FLEX (3.28')



Hard Wire Driver

- __FLE60-24V-L10-DIM (Linear)
- __FLE90-24V-L10-DIM (Linear)



Expanding Stick

- __FN-EPS

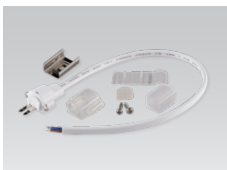

Field Termination

- __FN2-FTKIT-DUAL

A larger selection of drivers are available including remote and hard wire drivers. Please consult factory.

FLC30, FLC75 and XLD75 require the FDD-L20 for Dim to Warm/Tunable White

Individual Packaging includes 1 reel, bracket(4 pcs), screw(4 pcs), and end cap(1 pc)