

DATE PROJECT LOCATION TYPE



PRODUCT FEATURES

- Easy “Horizontal” Slide Connection System
- Vertical Slide-Up Replacement System
- Slim Design for Long Seamless Runs
- 1-10V Integrated Dimming
- Product is approved for Closet/Storage space installation per NEC410.16 (A) (3) and NEC410.16 (C)(5) per NRTL certification
- Adjustable Angled Mounting Bracket Available
- Magnetic Mounting Bracket Available
- Round Diffuser-Square Option – Special Order
- Universal Voltage

PRODUCT SPECIFICATIONS

- Voltage: AC 100-277V
- Operating Temperature: 32-104° F (0-40°C)
- Power Factor : PF>0.9
- Lamp Life: 40,000hr / 70%
- Available Color: *2200K, 2700K, 3000K, 3500K, 4000K
- CRI > 90
- 446lm/ft (VSSL 20W 40K)
- Max Connection per Single Power Feed
 - Dimming : 20pcs Max
 - Non-Dimming : 400W
 - 5W(80pcs), 10W(40pcs), 15W(26pcs), 20W(20pcs)



* 4000K performance data shown. Refer to individual luminaire IES files for other CCTs.

* Pending factory availability

Product	Model Number	Voltage Input	Energy Consumption	Luminous Flux	Luminous Efficacy	Color Rendering Index	Operating Temperature
VSSL	VSSL5 40K-UNV-C90	AC 100-277V	4.9W	410.4 lm	82lm/W	CRI > 90	0-40°C
	VSSL10 40K-UNV-C90	AC 100-277V	9.8W	730.3 lm	74.15lm/W	CRI > 90	0-40°C
	VSSL15 40K-UNV-C90	AC 100-277V	14.8W	1,208.3 lm	81.52lm/W	CRI > 90	0-40°C
	VSSL20 40K-UNV-C90	AC 100-277V	20.3W	1,697.4 lm	83.51lm/W	CRI > 90	0-40°C

MODEL SELECTION KEY

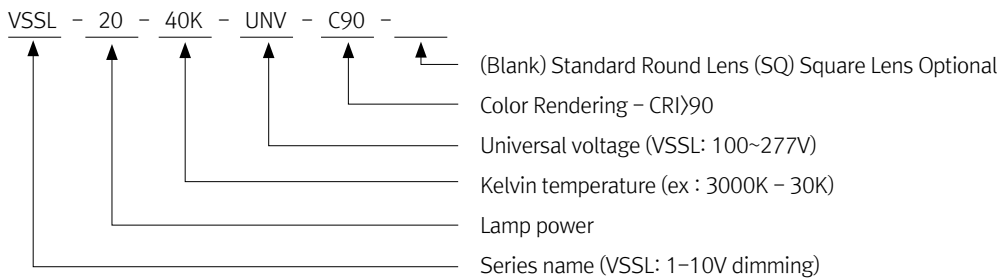

Square Lens-Special Order

SPECIFICATION GUIDE

NOT TO BE USED FOR ORDERING. The Specification Guide is intended solely to ensure that all options are considered.

MODEL	COLOR	LENS	MOUNTING	CONFIGURATION	RUN LENGTH	CONTROLS	VOLTAGE
VSSL	22K – 2200K* 27K – 2700K 30K – 3000K 35K – 3500K 40K – 4000K * Pending factory availability	ST Round Lens SQ Square Lens (optional with lead time)	STD Flat Brackets Included (Mounting Bracket) BK2 20° /40° Brackets BK-M Magnet Bracket	S –Straight V –Varies*	ft.	NDM NON-DIM ZT 0-10V DIM	120V 277V

* (Blank) Standard Round Lens

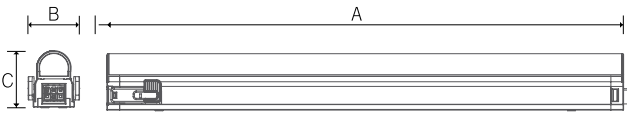

* (SQ) Square Lens Optional

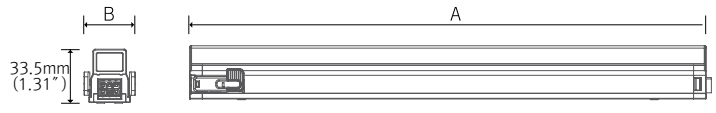

Product	Model Number	Dimension (mm)		
		A	B	C
VSSL	VSSL5 (color)K-UNV-C90	290mm(11.41")	32.3mm(1.27")	35.2mm(1.39")
	VSSL10 (color)K-UNV-C90	580mm(22.83")	32.3mm(1.27")	35.2mm(1.39")
	VSSL15 (color)K-UNV-C90	870mm(34.25")	32.3mm(1.27")	35.2mm(1.39")
	VSSL20 (color)K-UNV-C90	1160mm(45.67")	32.3mm(1.27")	35.2mm(1.39")

DIMENSION

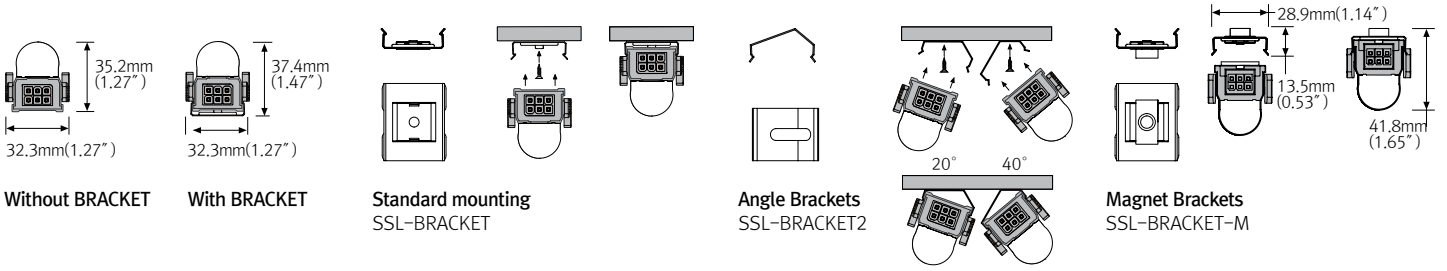

SLIDE CONNECTION SYSTEM

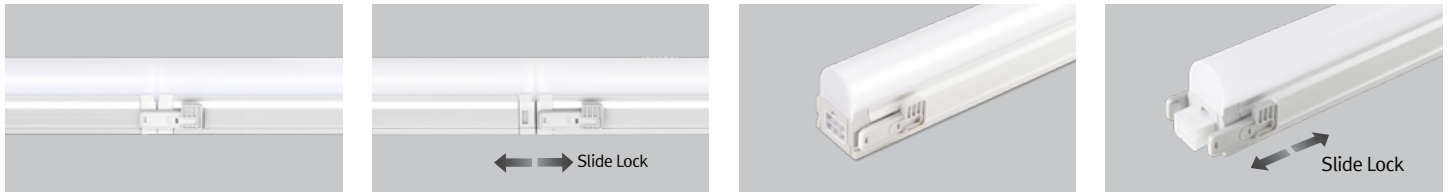

INSTALLATION

- VSSL

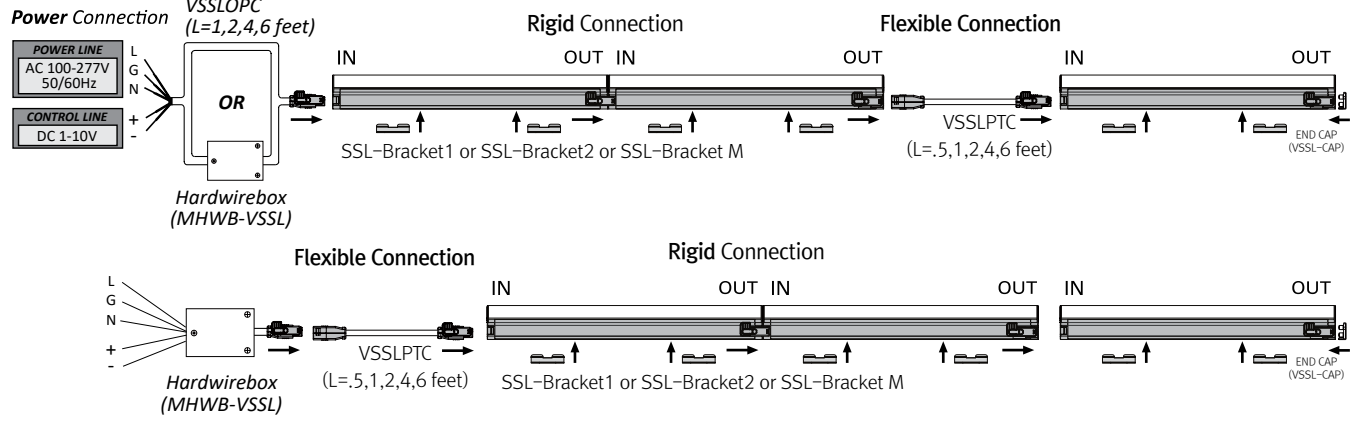

★ Installer instruction for Hardwirebox

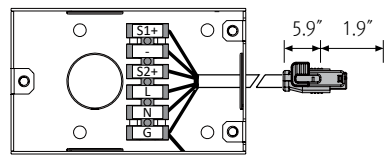

Metal Hardwirebox (MHWB-VSSL)
Box dimensions : 1.38"(deep), 2.25"(wide), 3.62"(long)

★ Wire Diagram

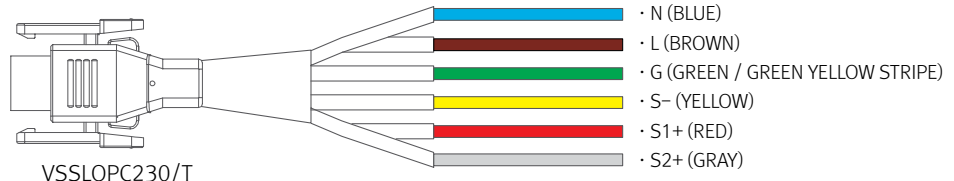

BEAM SPREADS

VSSL5 40K-UNV
82 lm/W
410.4 lm

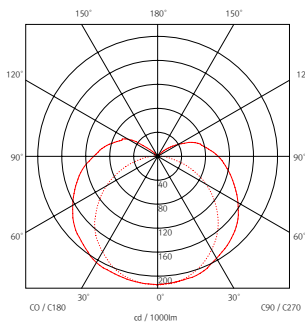

VSSL10 40K-UNV
74.15 lm/W
730.3 lm

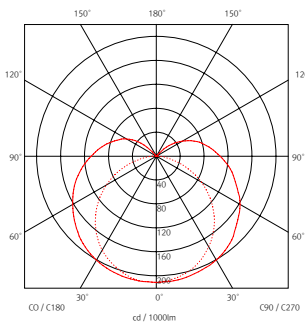

VSSL15 40K-UNV
81.52 lm/W
1,208.3 lm

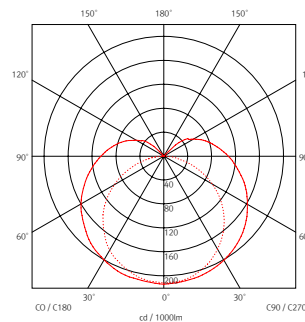

VSSL20 40K-UNV
83.51 lm/W
1697.4 lm

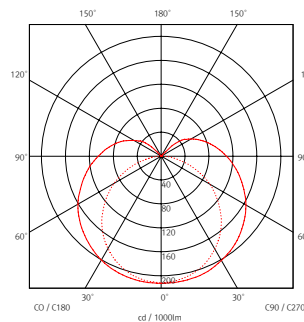

4000K performance data shown. Refer to individual luminaire IES files for other CCTs.

ACCESSORIES

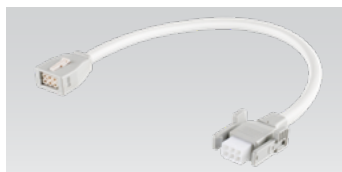

Connecting Cable

- __VSSLPTC/XL (6')
- __VSSLPTC1/XL (1')
- __VSSLPTC2/XL (2')
- __VSSLPTC4/XL (4')
- __VSSLPTC6/XL (6')



Open Power Cord

- __VSSLOPC120/XL (6')
- __VSSLOPC1/XL (1')
- __VSSLOPC2/XL (2')
- __VSSLOPC4/XL (4')

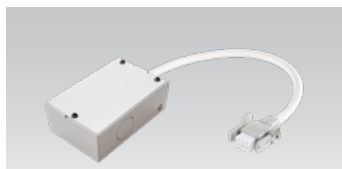

Hard Wire Box

- __MHWB-VSSL



Mounting Brackets (Included fixture)

- __SSL-BRACKET(A) : 1 set = 2pcs
- __SSL-BRACKET(B) : 1 set = 3pcs



Angle Brackets (Optional)

- __SSL-BRACKET2(A) : 1 set = 2pcs
- __SSL-BRACKET2(B) : 1 set = 3pcs



Magnet Brackets (Optional)

- __SSL-BRACKET-M(A) : 1 set = 2pcs
- __SSL-BRACKET-M(B) : 1 set = 3pcs